



GAZEBO PENGUIN INC.

4660 Hickmore, St-Laurent
Quebec, Canada H4T 1K2

1-800-737-7174 / 514-276-3485

Fax : 1-514-276-4147

customerservice@gazebopenguin.com

43202 10'x12' GAZEBO ASSEMBLY INSTRUCTIONS

**PLEASE READ
IN ITS ENTIRETY
BEFORE
INSTALLATION**

**PLEASE READ
IN ITS ENTIRETY
BEFORE
INSTALLATION**

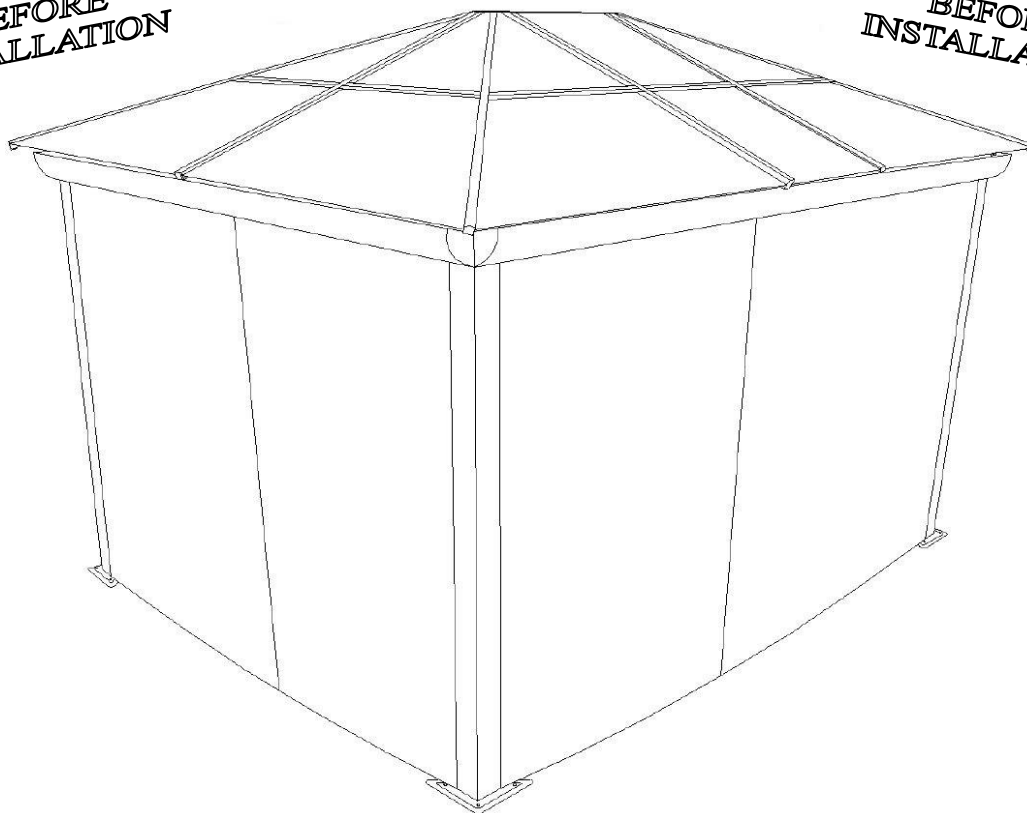

**DO NOT DESTROY THE BOXES UNTIL COMPLETELY ASSEMBLED
PLEASE VERIFY THE CONTENT OF EACH BOX AGAINST THE LIST OF PARTS**
Assembly with more than one person recommended

Tools required (not provided):

6ft (1.8m) stepladder, Robinson #2 Screwdriver, mallet, safety gloves & glasses, tarp or protective material for placing parts on during assembly, tape measure, 1'X2"X4" wood.

Before you assemble the Gazebo

- Please don't destroy boxes until completely assembled.
- Please verify the content of each box against the list of parts.
- It is important that this gazebo be anchored on a solid base with the provided screws. Otherwise, please ensure that you use anchors sufficient for your surface.
- The gazebo should not be installed adjacent to trees or a sloped roof. Snow and ice may slide onto the gazebo and cause it to collapse.

Step 1:

Assemble beams "A" and "B" using center plate "F", securing tightly with 8 bolts "Pp". Repeat with beams "C" and "D", also using center plate "F". Lay out the assembled beams in a rectangle and join at each corner with a corner plate "E", again securing tightly with 8 bolts "Pp".

SKETCH 1

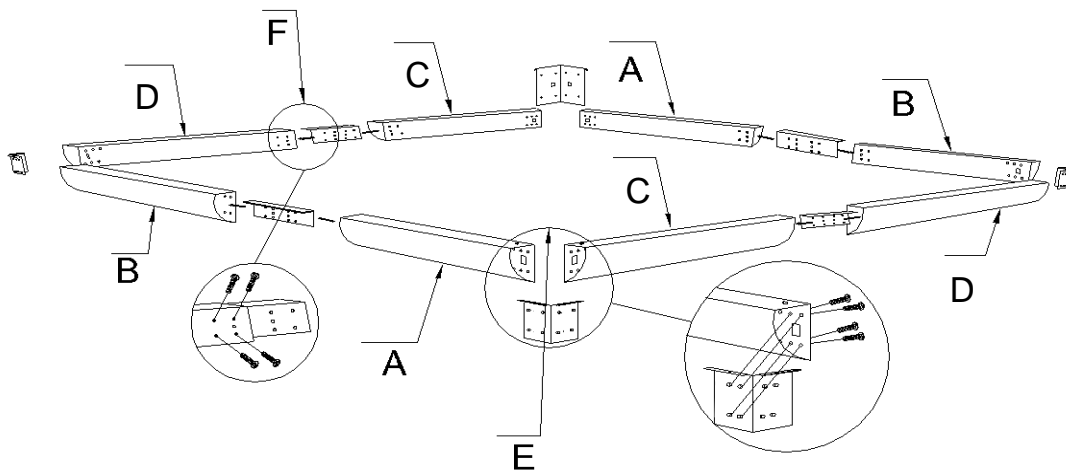

SKETCH 2

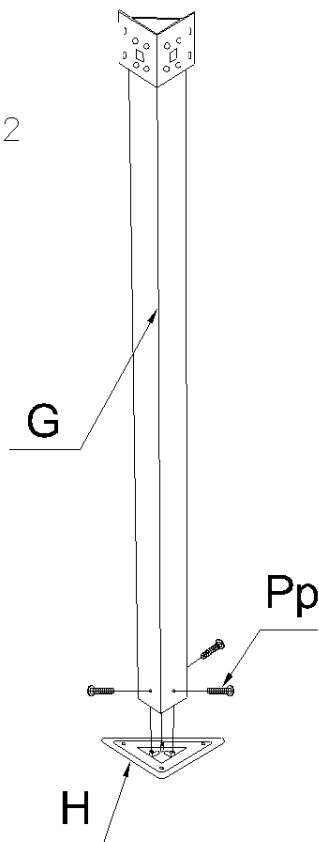

Step 2:

For each leg "G", attach foot plate "H" using 3 bolts "Pp".

Step 3:

Have someone lift the beam assembly and attach each leg "G" into a corner, securing each using 4 bolts "Pp". Repeat until all four legs are in place.

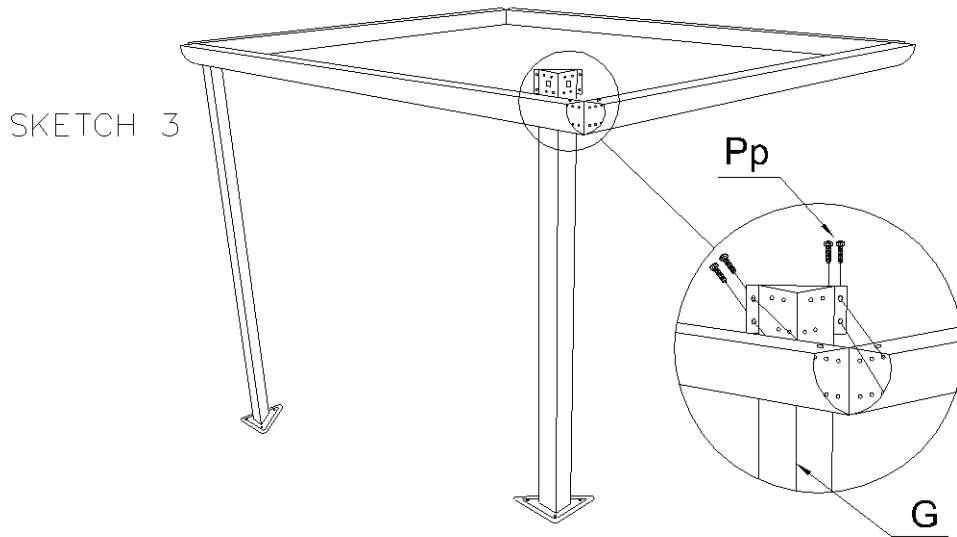

Step 4:

Install middle joint cover "J" at each of the 4 beam junctions, using 4 screws "Qq" each.
Install corner cover "I" at each of the corners, using 4 screws "Qq" each.

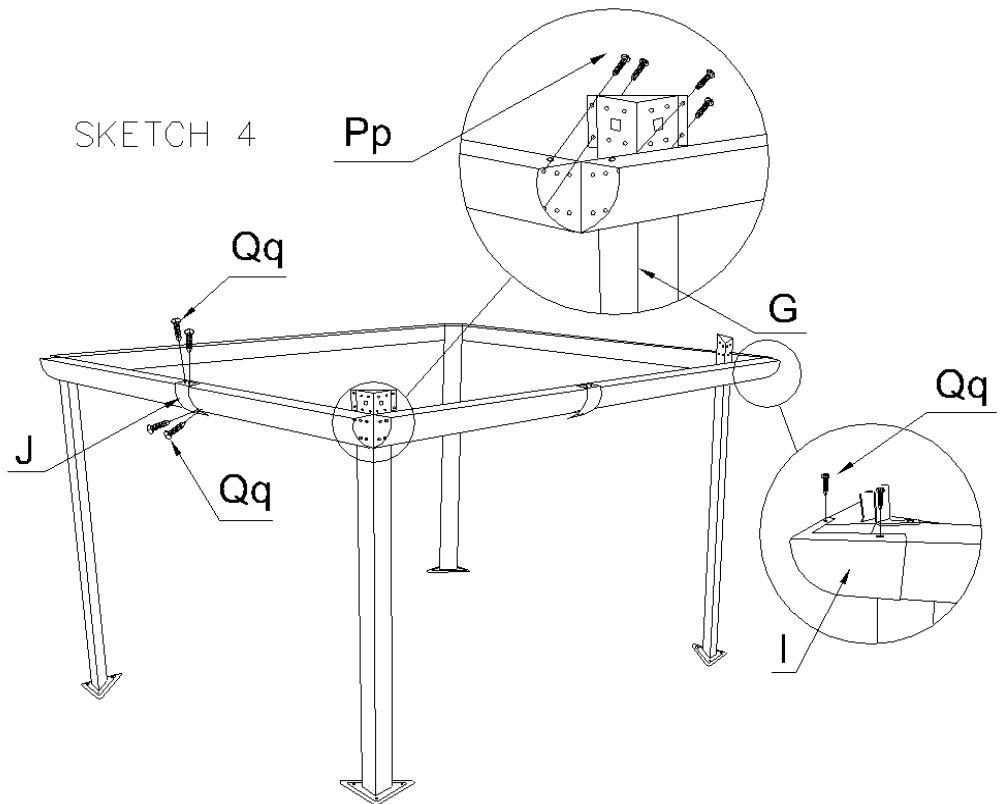

Step 5:

Attach mounting brackets “O” and “P” to rafters “M” and “N” respectively. Use threaded hole about 8” from end of rafter.

Lift central hub “L” to a height of about 110” (2.79m) at the center of the gazebo. (Caution: this part may be heavy, use support as needed)

Attach one end of rafter “M” to the hub using 1 bolt “Pp”. Attach other end with mounting bracket to the corner of the beam assembly with 2 bolts “Pp”. Repeat with remaining “M” rafters.

Similarly, attach one end of rafter “N” to the hub using 1 bolt “Pp”. Attach other end with mounting bracket to the beam assembly with 2 screws “Qq”. Use the set of holes closes to the inside. Repeat with remaining “N” rafters.

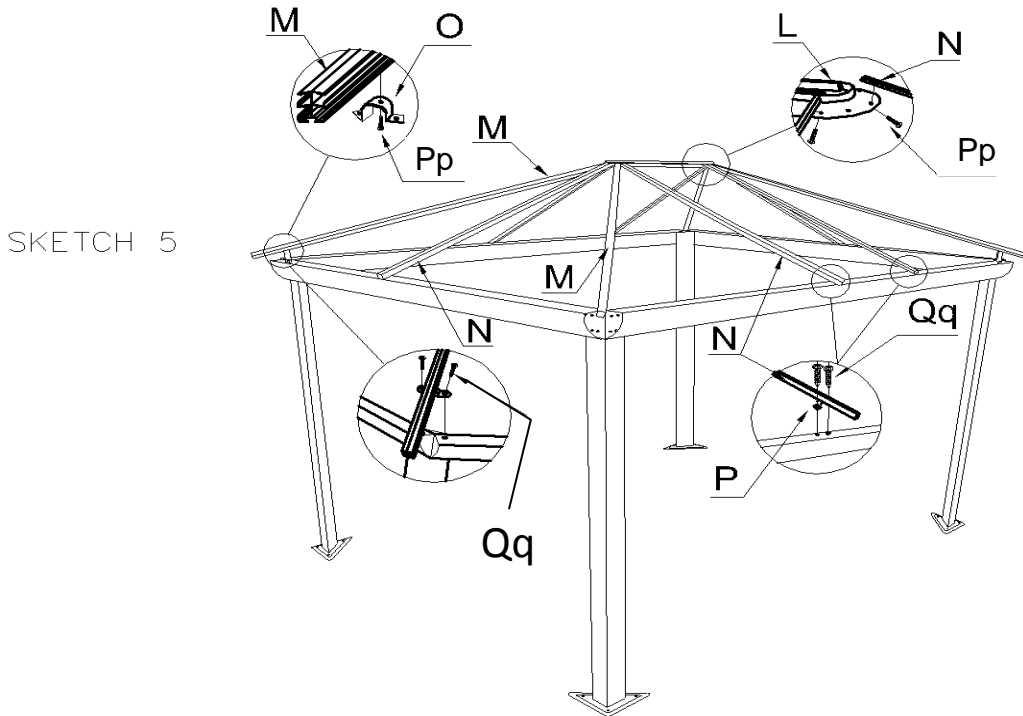

Step 6:

Once all rafters are in place, install top cap “K” over central hub “L”. Use flat washers and acorn nuts “Vv” to secure tightly.

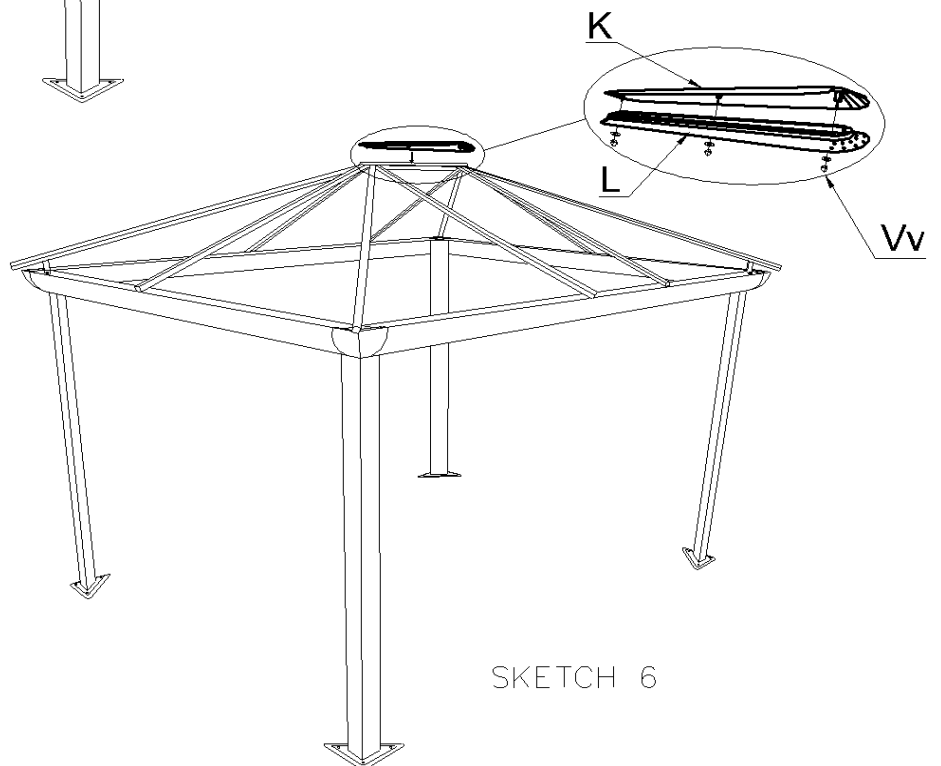

Step 7:

Install the flashings “Q”, “R”, and “S” onto the beam assembly, using screws “Qq” on the inside. The notched end of a flashing will always go in a corner of the gazebo.

SKETCH 7

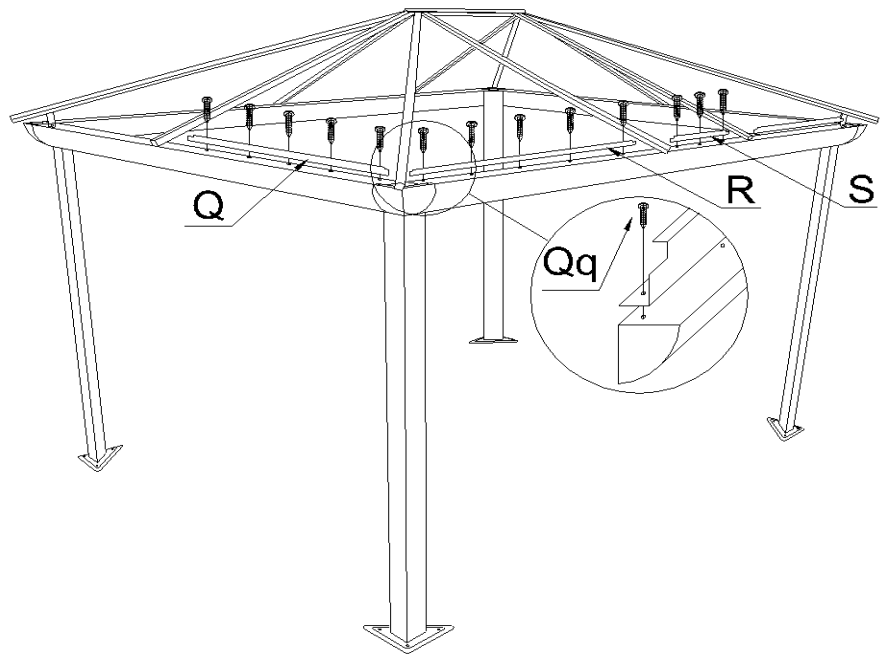

Step 8:

Install the curtain rails “T” and “U” on the inside of the beam assembly using bolts “Pp”.

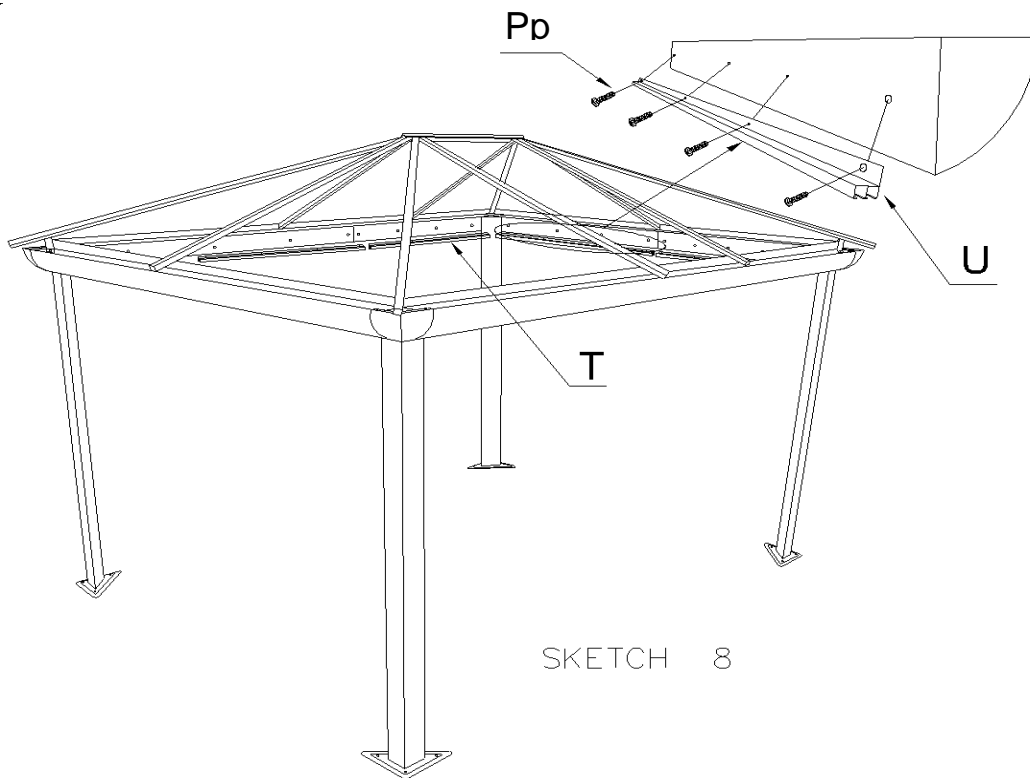

SKETCH 8

Step 9:

Slide the indicated polycarbonate panels into the spaces between the rafters, using the top groove of each rafter. Ensure the side meant to face the sun is on the outside. Use a rubber hammer to carefully tap each panel into the grooves.

SKETCH 9
TOP VIEW

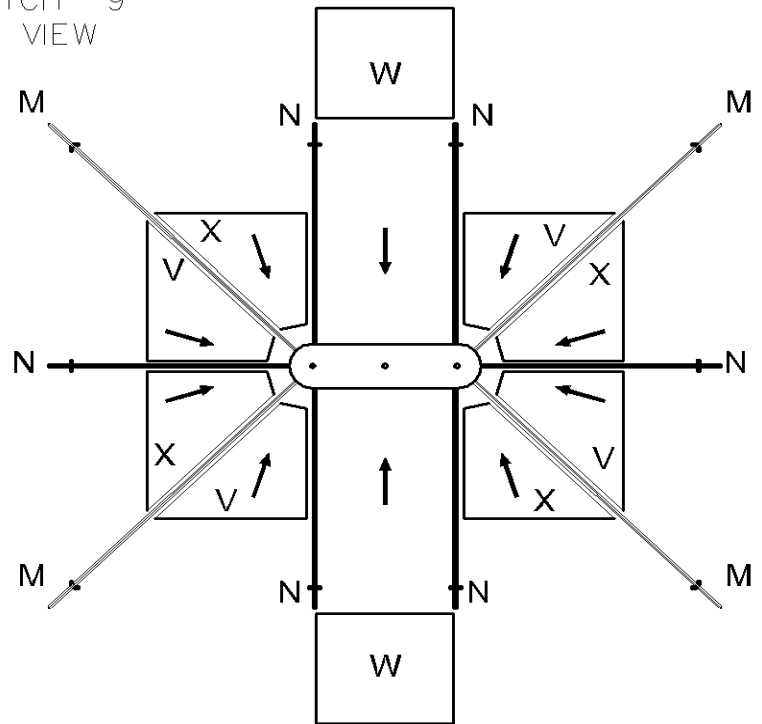

Step 10:

Insert the middle roof joints in between the rafters and slide them up under the polycarbonate panels. Tap lightly to ensure the panel is fully in the slot. Seen from above, most of the joint as well as the drain holes should be beneath the roof panels.

To adjust the middle joints to line up : once all polycarbonate roof panels are in place, use a small piece of wood and hammer, then tap down on the middle of the joint bringing it down and holding at the same time the joint and top polycarbonate.

Do not tap too hard.

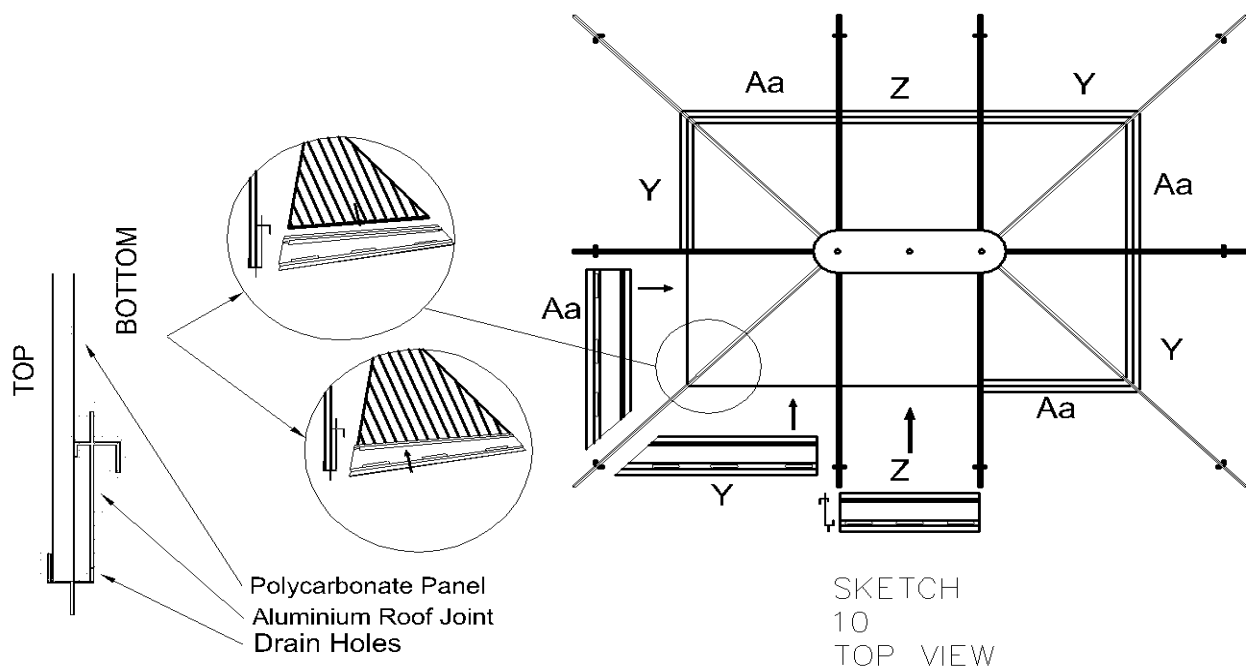

SKETCH 10
TOP VIEW

Step 11:

Slide the remaining polycarbonate roof panels in the lower groove of the rafters and into the lower slot of the roof joints. Tap to make sure panels fit securely and do not extend past the ends of the rafters.

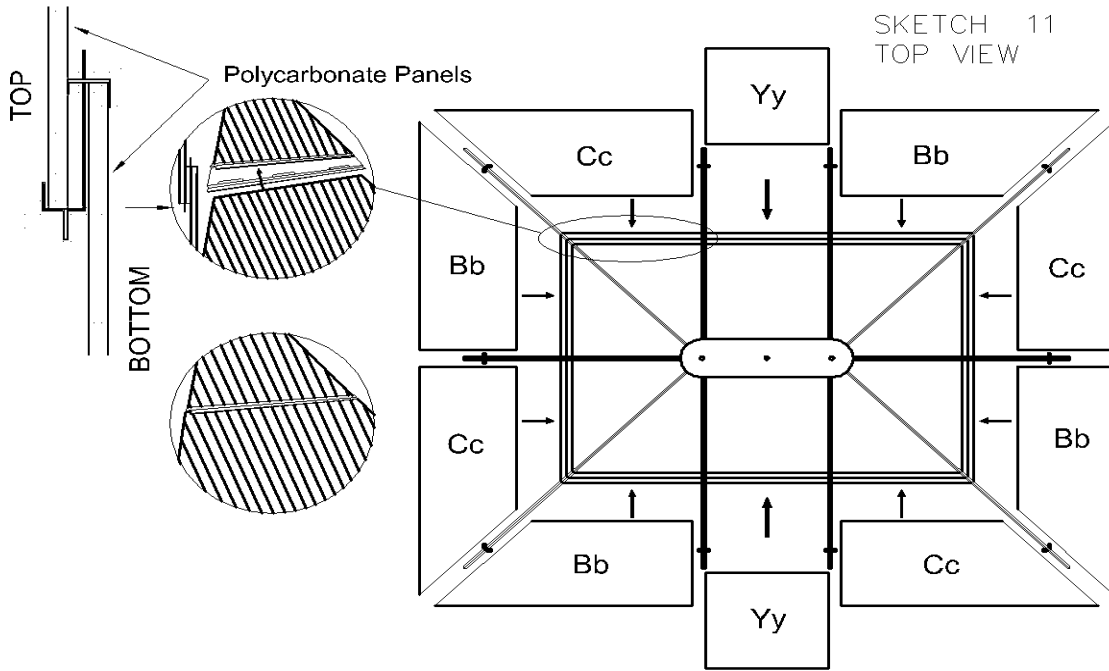

Step 12:

Starting from any end, install all edgings, with end caps "Gg" or "Hh" at each junction or corner respectively. Use bolts "Pp" to secure.

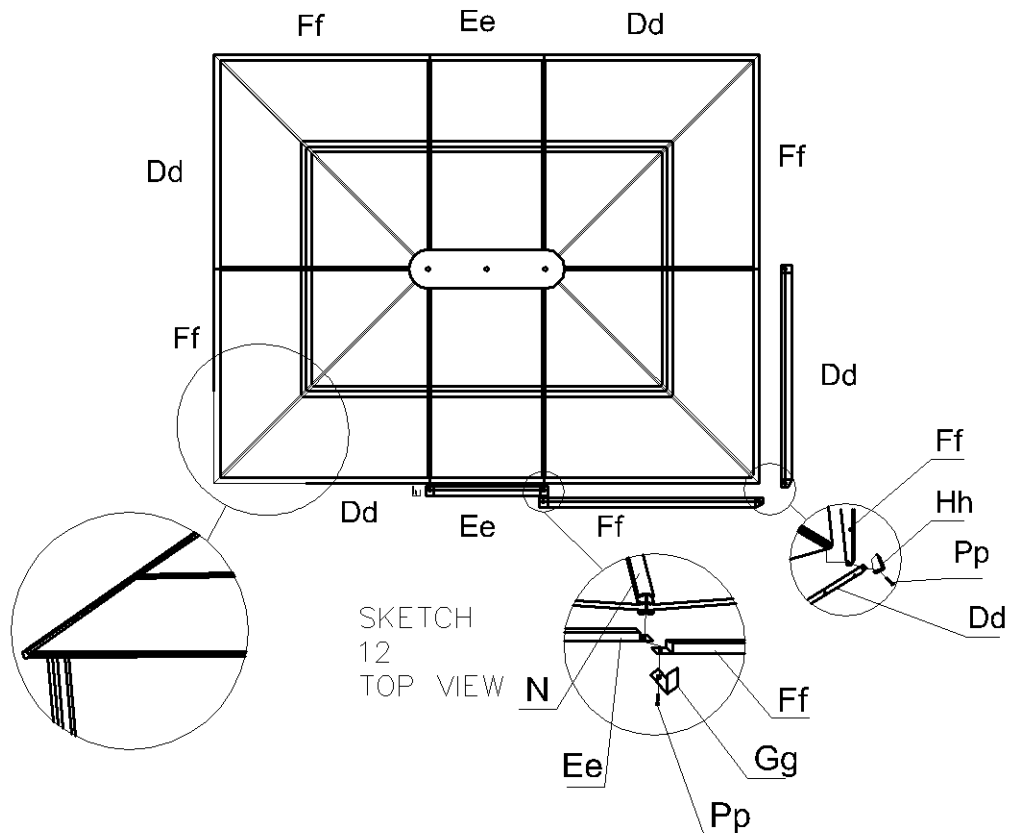

Step 13:

Install the upper crossbars on the interior of the roof using bolts "Pp", following the shaped ends and letters. Do not tighten bolts immediately; install loose and tighten once all crossbars are in place.

Repeat this step with the lower crossbars.

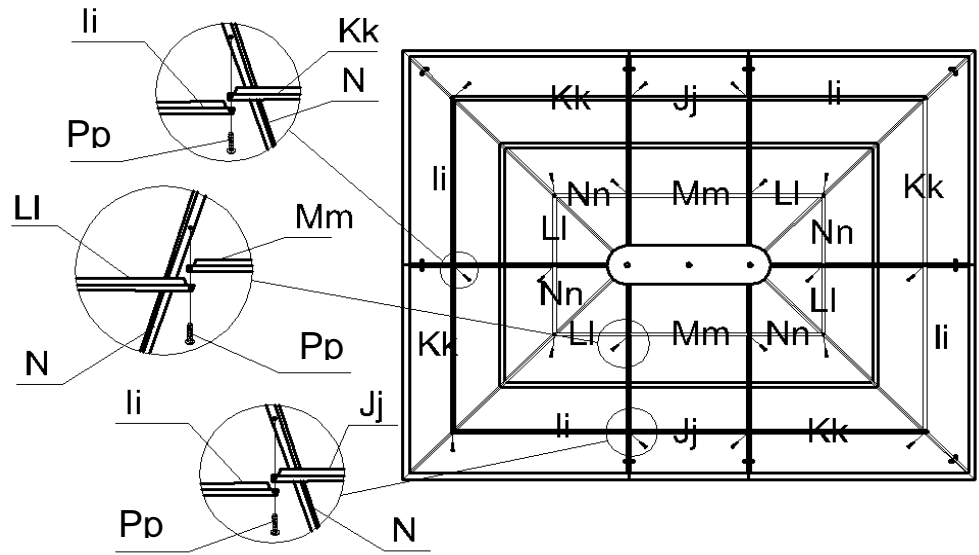

SKETCH 13
BOTTOM VIEW

Step 14:

- a) Secure each foot plate into the ground using screws "Rr" and washers "Tt".
- b) Use lag shields (Ss) if needed for harder surfaces.

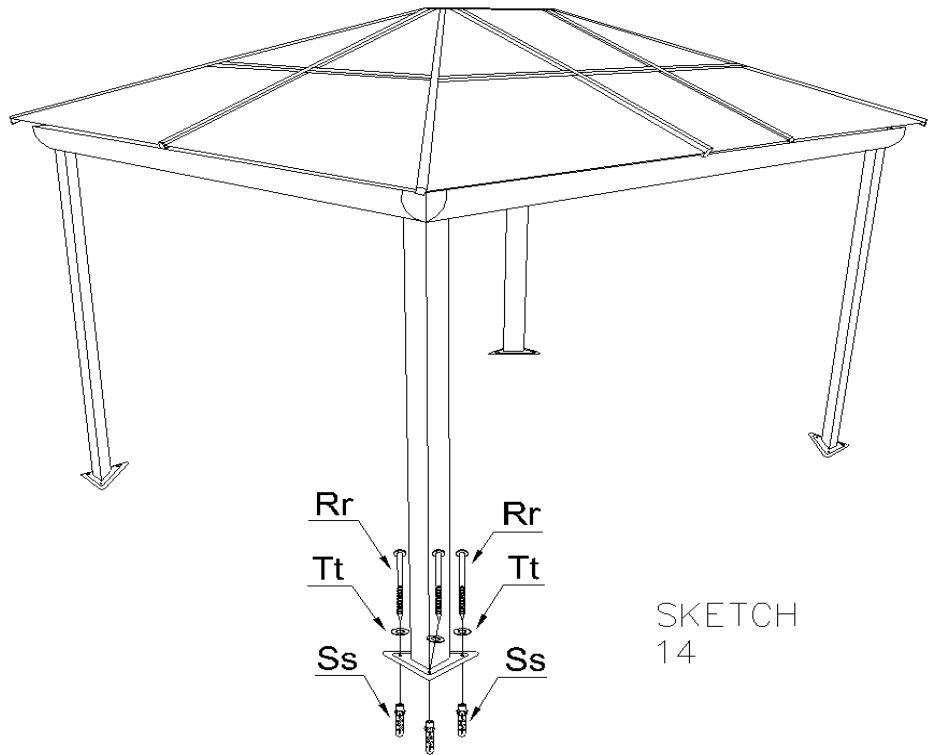

SKETCH 14

Step 15:

Install the screen curtains “Ww” in the interior groove of the curtain rails, using the provided hooks. Install the privacy curtains “Xx” in the exterior groove of the rails. Once the hooks are in, use curtain rail caps “Uu” to close ends of curtain rails.

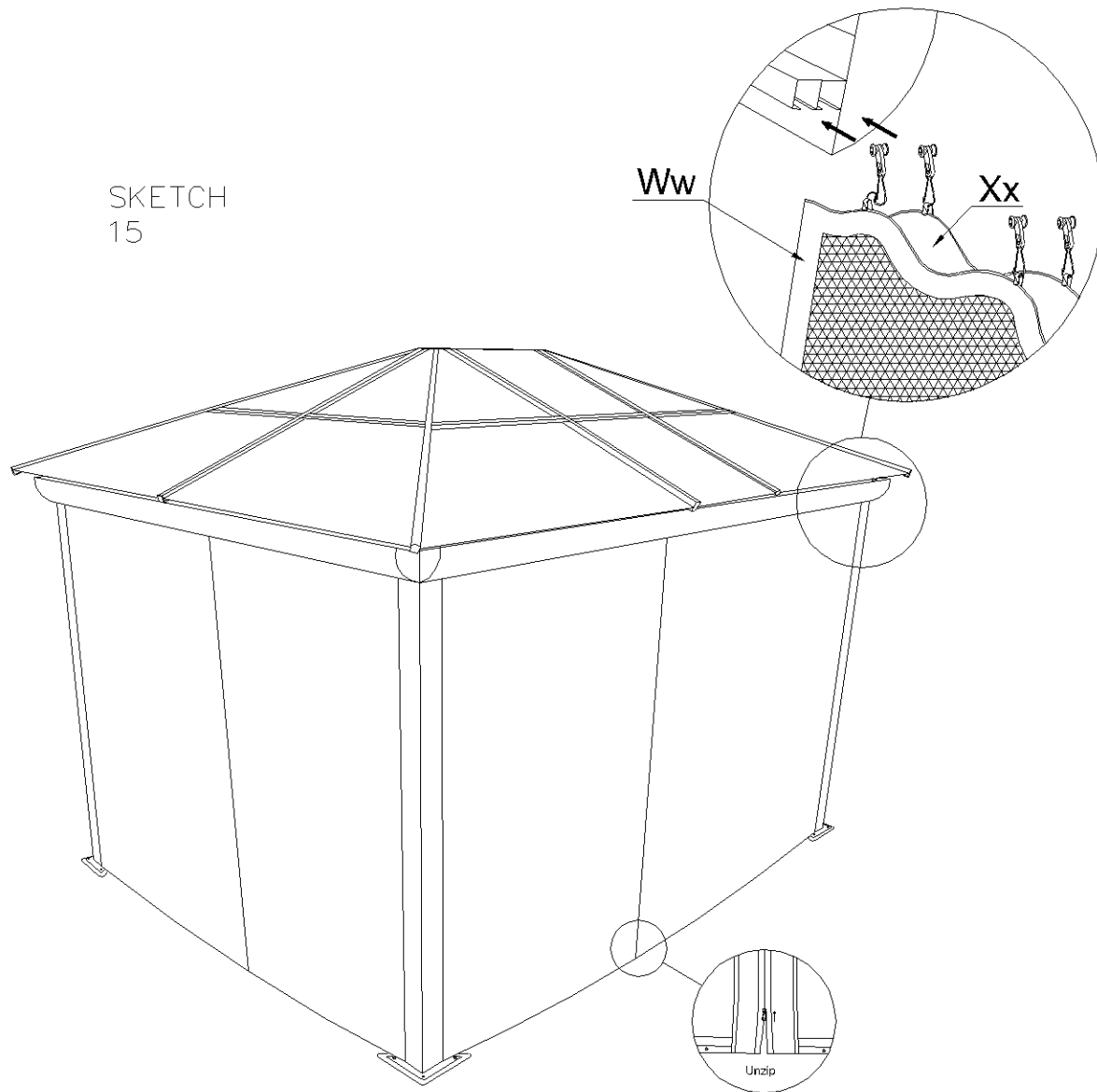









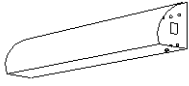

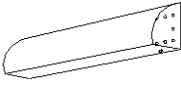

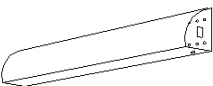

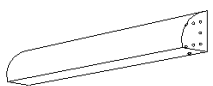
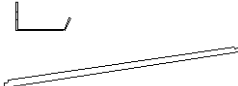
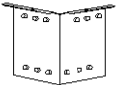

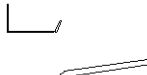
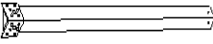
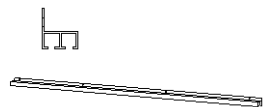
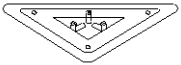

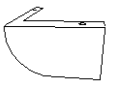
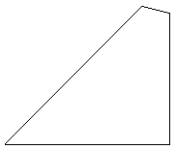

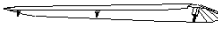
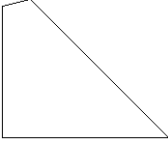

IMPORTANT NOTES:

Make sure all screws and bolts are tight.

If conditions are windy, you may have to add cable guides at the corners.

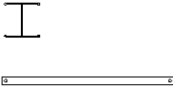

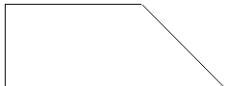

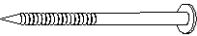

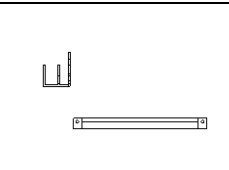
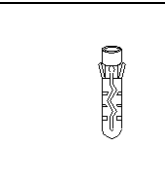
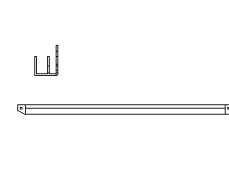
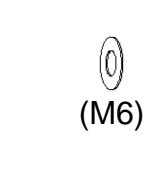
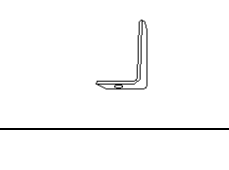
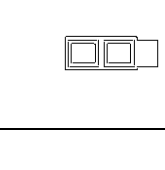
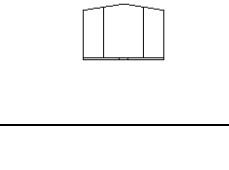
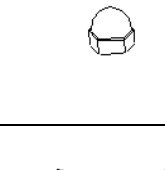
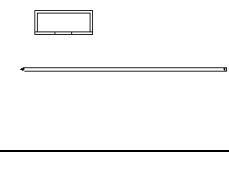
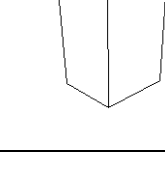
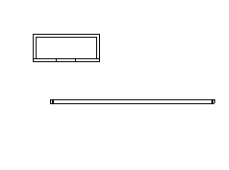
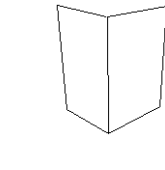
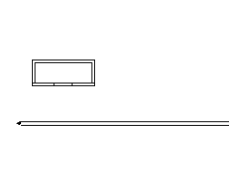
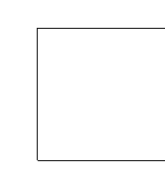
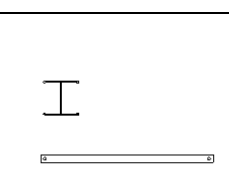
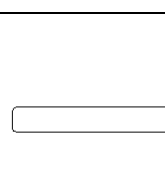
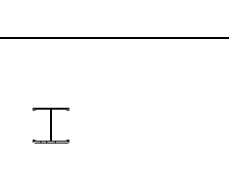
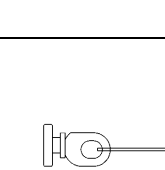

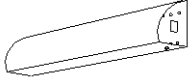

43202-22 DARK BROWN PARTS LIST

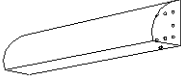

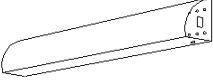

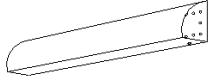
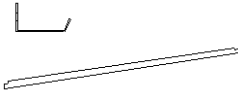
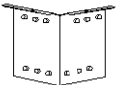
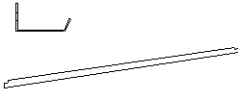
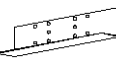
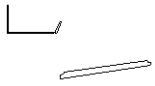
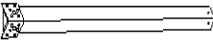

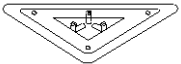

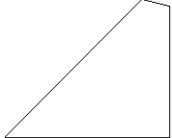

PART	PACKED IN BOX	QTY	DIAGRAM	PART	PACKED IN BOX	QTY	DIAGRAM
(11-624-22) 52 3/4" TOP LEFT BEAM A	3	2		(11-637-22) 60 3/8" ROOF RAFTER N	2	6	
(11-625-22) 52 3/4" TOP RIGHT BEAM B	3	2		RAFTER M MOUNTING BRACKET O	2	4	
(11-626-22) 65 1/2" TOP LEFT BEAM C	3	2		RAFTER N MOUNTING BRACKET P	2	6	
(11-627-22) 65 1/2" TOP RIGHT BEAM D	3	2		(11-638-22) 55 1/4" RIGHT FLASHING Q	2	4	
(11-628-22) CORNER PLATE E	3	4		(11-639-22) 55 1/4" LEFT FLASHING R	2	4	
(11-629-22) CENTER PLATE F	3	4		(11-640-22) 25 3/8" CENTER FLASHING S	2	2	
(11-630-22) 81 1/2" LEG G	3	4		(11-641-22) 60 1/2" CURTAIN RAIL, 12' SIDE T	2	4	
(11-631-22) FOOT PLATE H	3	4		(11-642-22) 47 3/4" CURTAIN RAIL, 10' SIDE U	2	4	
(11-632-22) CORNER COVER I	3	4		(11-643-22) 30"x30" LEFT UPPER ROOF PANEL V	1	4	

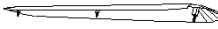
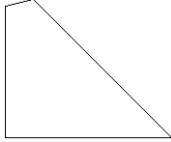





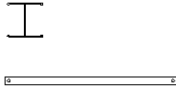
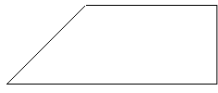
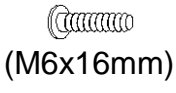
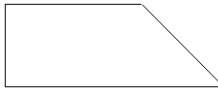

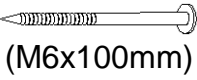





PART	PACKED IN BOX	QTY	DIAGRAM	PART	PACKED IN BOX	QTY	DIAGRAM
(11-633-22) MIDDLE COVER J	3	4		(11-644-22) 29 1/2"x25 1/2" MIDDLE UPPER ROOF PANEL W	1	2	
(11-634-22) 37 1/4" TOP CAP K	2	1		(11-645-22) 30"x30" RIGHT UPPER ROOF PANEL X	1	4	
(11-635-22) 34 1/4" CENTRAL HUB L	2	1		(11-646-22) 30 3/4" LEFT MIDDLE ROOF JOINT Y	2	4	
(11-636-22) 83" ROOF RAFTER M	2	4		(11-647-22) 25 1/2" CENTER MIDDLE ROOF JOINT Z	2	2	
(11-648-22) 30 3/4" RIGHT MIDDLE ROOF JOINT Aa	2	4		(11-661-22) 17 1/2" RIGHT UPPER CROSSBAR Nn	2	4	
(11-649-22) 33"x58 1/8" LEFT LOWER ROOF PANEL Bb	1	4		(08-158-22) BOLT Pp	3	182	 (M6x16mm)
(11-650-22) 33"x58 1/8" RIGHT LOWER ROOF PANEL Cc	1	4		(08-156-22) SCREW Qq	3	92	 (M4x16mm)
(11-651-22) 58 7/8" LEFT EDGING Dd	2	4		(08-167-22) SCREW Rr	3	12	 (M6x100mm)

PART	PACKED IN BOX	QTY	DIAGRAM	PART	PACKED IN BOX	QTY	DIAGRAM
(11-652-22) 26 3/4" CENTER EDGING Ee	2	2		(08-193-22) PLASTIC PLUG Ss	3	12	
(11-653-22) 58 7/8" RIGHT EDGING Ff	2	4		(08-187-22) WASHER Tt	3	15	
(11-654-22) RAFTER CAP Gg	2	6		(11-697-22) CURTAIN RAIL CAP Uu	3	8	
(11-655-22) CORNER END BRACKET Hh	2	4		(08-189-22) ACORN NUT Vv	3	3	
(11-656-22) 44" LEFT LOWER CROSSBAR Ii	2	4		(11-695-22) SCREEN/MOU STIQUEAIRE Ww	2	4	
(11-657-22) 26 3/4" MIDDLE LOWER CROSSBAR Jj	2	2		(11-696-22) PRIVACY CURTAIN Xx	2	4	
(11-658-22) 44" RIGHT LOWER CROSSBAR Kk	2	4		(11-706-22) 33"x25 1/2" MIDDLE LOWER ROOF PANEL Yy	1	2	
(11-659-22) 17 1/2" LEFT UPPER CROSSBAR Ll	2	4		10 mm KEY	3	1	
(11-660-22) 26 3/4" MIDDLE UPPER CROSSBAR Mm	2	2		(11-705-22) CURTAIN HOOKS	3	96	

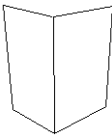
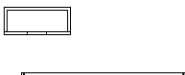
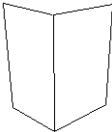
43202-32 SLATE PARTS LIST

PART	PACKED IN BOX	QTY	DIAGRAM	PART	PACKED IN BOX	QTY	DIAGRAM
(11-624-32) 52 3/4" TOP LEFT BEAM A	3	2		(11-637-32) 60 3/8" ROOF RAFTER N	2	6	
(11-625-32) 52 3/4" TOP RIGHT BEAM B	3	2		RAFTER M MOUNTING BRACKET O	2	4	
(11-626-32) 65 1/2" TOP LEFT BEAM C	3	2		RAFTER N MOUNTING BRACKET P	2	6	
(11-627-32) 65 1/2" TOP RIGHT BEAM D	3	2		(11-638-32) 55 1/4" RIGHT FLASHING Q	2	4	
(11-628-32) CORNER PLATE E	3	4		(11-639-32) 55 1/4" LEFT FLASHING R	2	4	
(11-629-32) CENTER PLATE F	3	4		(11-640-32) 25 3/8" CENTER FLASHING S	2	2	
(11-630-32) 81 1/2" LEG G	3	4		(11-641-32) 60 1/2" CURTAIN RAIL, 12' SIDE T	2	4	
(11-631-32) FOOT PLATE H	3	4		(11-642-32) 47 3/4" CURTAIN RAIL, 10' SIDE U	2	4	
(11-632-32) CORNER COVER I	3	4		(11-643-32) 30"x30" LEFT UPPER ROOF PANEL V	1	4	

PART	PACKED IN BOX	QTY	DIAGRAM	PART	PACKED IN BOX	QTY	DIAGRAM
(11-633-32) MIDDLE COVER J	3	4		(11-644-32) 29 1/2"x25 1/2" MIDDLE UPPER ROOF PANEL W	1	2	
(11-634-32) 37 1/4" TOP CAP K	2	1		(11-645-32) 30"x30" RIGHT UPPER ROOF PANEL X	1	4	
(11-635-32) 34 1/4" CENTRAL HUB L	2	1		(11-646-32) 30 3/4" LEFT MIDDLE ROOF JOINT Y	2	4	
(11-636-32) 83" ROOF RAFTER M	2	4		(11-647-32) 25 1/2" CENTER MIDDLE ROOF JOINT Z	2	2	
(11-648-32) 30 3/4" RIGHT MIDDLE ROOF JOINT Aa	2	4		(11-661-32) 17 1/2" RIGHT UPPER CROSSBAR Nn	2	4	
(11-649-32) 33"x58 1/8" LEFT LOWER ROOF PANEL Bb	1	4		(08-158-32) BOLT Pp	3	182	
(11-650-32) 33"x58 1/8" RIGHT LOWER ROOF PANEL Cc	1	4		(08-156-32) SCREW Qq	3	92	
(11-651-32) 58 7/8" LEFT EDGING Dd	2	4		(08-167-32) SCREW Rr	3	12	

PART	PACKED IN BOX	QTY	DIAGRAM	PART	PACKED IN BOX	QTY	DIAGRAM
(11-652-32) 26 3/4" CENTER EDGING Ee	2	2		(08-193-32) PLASTIC PLUG Ss	3	12	
(11-653-32) 58 7/8" RIGHT EDGING Ff	2	4		(08-187-32) WASHER Tt	3	15	
(11-654-32) RAFTER CAP Gg	2	6		(11-697-32) CURTAIN RAIL CAP Uu	3	8	
(11-655-32) CORNER END BRACKET Hh	2	4		(08-189-32) ACORN NUT Vv	3	3	
(11-656-32) 44" LEFT LOWER CROSSBAR Ii	2	4		(11-695-32) SCREEN/MOU STIQUEAIRE Ww	2	4	
(11-657-32) 26 3/4" MIDDLE LOWER CROSSBAR Jj	2	2		(11-696-32) PRIVACY CURTAIN Xx	2	4	
(11-658-32) 44" RIGHT LOWER CROSSBAR Kk	2	4		(11-706-32) 33"x25 1/2" MIDDLE LOWER ROOF PANEL Yy	1	2	
(11-659-32) 17 1/2" LEFT UPPER CROSSBAR Ll	2	4		10 mm KEY	3	1	
(11-660-32) 26 3/4" MIDDLE UPPER CROSSBAR Mm	2	2		(11-705-32) CURTAIN HOOKS	3	96	

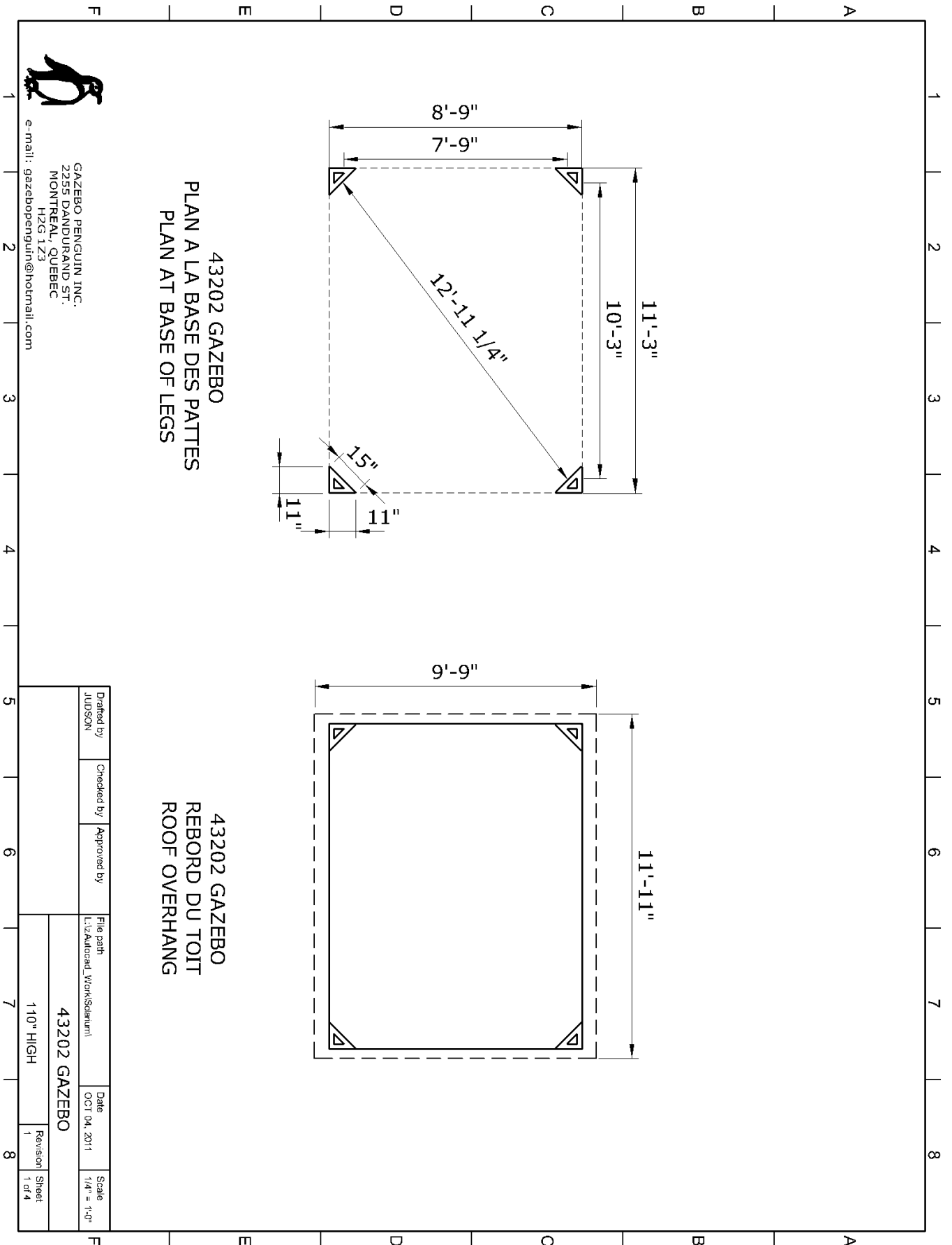

GAZEBO PENGUIN INC.
 2255 DANDURAND ST.
 MONTREAL, QUEBEC
 H2G 1Z3
 e-mail: gazebopenguin@hotmail.com

Drafted by JUDSON	Checked by	Approved by	File path L:\z\Autocad_WorkSpace\unim	Date OCT 04, 2011	Scale 1/4" = 1'-0"
43202 GAZEBO			110" HIGH	Revision	Sheet
				1	1 of 4

MAINTENANCE NOTES

1. In case of a defective or damaged part, or for any other questions concerning the product, please contact the manufacturer directly.
2. Please have the parts list and part numbers on hand when ordering or requesting replacement parts.
3. The product should not be installed adjacent to trees or a sloped roof. Snow and ice may slide onto the roof and cause it to collapse.
4. While the product is designed for 4 seasons use, the roof must be kept free of accumulation of snow.



ONE YEAR LIMITED WARRANTY

This product has been designed and manufactured to meet the highest standards of quality and durability. Subject to the Conditions for Exercising the Warranty and the Limitations on the Warranty set forth below, it is warranted to be free of material and manufacturing defects for a period of **one year** from the date of purchase. Should the product become damaged, or the warranty period has expired, please contact Gazebo Penguin Customer Service Department for a complete schedule of replacement parts and prices.

CONDITIONS FOR EXERCISING THE WARRANTY

The warranty only applies to the original purchaser with the bill.

In order to properly exercise your warranty, please comply with the following:

Carefully inspect the contents of the carton for missing or damaged components. Should you discover damaged or missing parts, **do not return the product to the place of purchase**, but contact Gazebo Penguin Customer Service Department at the numbers listed below:

Montreal: (514) 276-3485

Elsewhere: 1-800-737-7174

You can also find a claim form to fill out online :

<http://www.abrispenguin.com/forms.html>

LIMITATIONS ON THE WARRANTY

1. The product is not warranted against damages due to vandalism, abuse, falling or thrown objects, or accumulation of snow.
2. The product is not warranted against damages due to extreme weather conditions, such as thunderstorms, hail, strong wind or snow storms, or any other acts of God.
3. The product is only warranted in the event it is installed in accordance with the Gazebo Penguin's written instructions enclosed with the product.
4. The product is not warranted in the event it has been improperly anchored.
5. We reserve the right to replace or repair any defective product or parts at our discretion.